

K109LV

Shunt / V-I isolated converter

K-Line

CE



TEMPERATURE
CONVERTERS

ANALOG
CONVERTERS

SERIAL
CONVERTERS

ACCESSORIES

- ▶ Input: setted scales from ± 25 mV up to ± 2000 mV
- ▶ Output: current 0/4..20, 20..4/0 mA or voltage 0..5/10, 10..0, 1..5 Vdc
- ▶ Max consumption 22 mA
- ▶ 3 way galvanic isolation: 1,5 kVac
- ▶ Measure resolution @ 14 bit
- ▶ Precisione class 0,1%
- ▶ Power supply on spring-cage terminal or distributed supply with 2 slot connector, K-BUS
- ▶ Tiny dimensions (6,2 x 93,1 x 102,5 mm)

TECHNICAL SPECIFICATIONS

K109LV · Shunt / V-I isolated converter



ORDER CODES

Code	Description	
Model	K109LV	Shunt / V-I isolated converter
Accessories	K-BUS	Fast supply expandable connector
	K-SUPPLY	Power supply module with surge protection

GENERAL DATA

Power supply	19,2..30 Vdc
Channels number	1 input, 1 output
Thermal drift	120 ppm/K
Status indicators	Fault, alarm
Isolation	1,5 kVac (50 Hz, 1 min), digital technique
Power on side terminals	Yes
Hot swapping	Yes
Max current consumption	22 mA a 24 Vdc
Consumption without load	7,5 mA (at 25°C)
Max power consumption	500 mW
A/D conversion	14 bit
Rejection	50 – 60 Hz (programmabile)
Settings	DIP switch
Filter	Insertable
Dimensions	6,2 x 93,1 x 102,5 mm
Processing	Floating point 32 bit
Case, weight, colour	PBT, 45 g, nero
Operating temperature	-20..+65 °C
Bridge voltage supply	Bus connectors (K-BUS) can be snapped onto 35 mm DIN guide rail according to EN 60175)
Protection degree	IP20
Conformity	CE, EN 61010-1, EN 60742, EN 61000-6-4, EN 61000-6-2

INPUT DATA

Type	SHUNT
Range:	± 25, 50, 60, 75, 80, 100, 120, 150, 200, 250, 300, 400, 500, 1000, 2000 mV (settable via Dip-switch)
Max voltage	± 50 V

OUTPUT DATA

Type	VOLTAGE
Range:	0..10/10..0/0..5/1..5 V
Min load resistance:	2 kΩ
CURRENT	
Range:	4..20/20..4/0..20/20..0 mA
Max load resistance:	500 Ω
Protection:	25 mA

CONNECTING AND INSTALLING

INSERTING / EXTRACTING MODULES

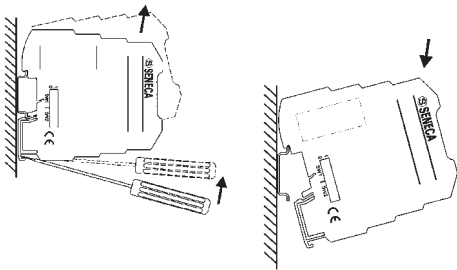

K-BUS

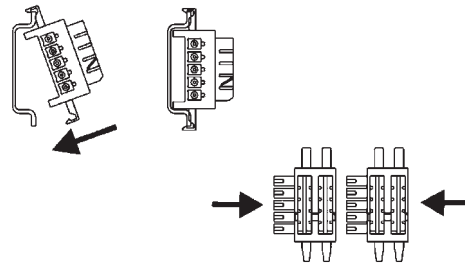

CAGE CLAMP CONNECTION

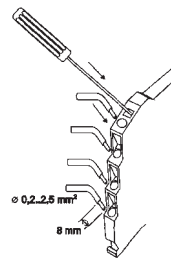

POWER SUPPLY

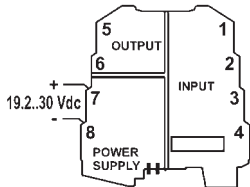

INPUT

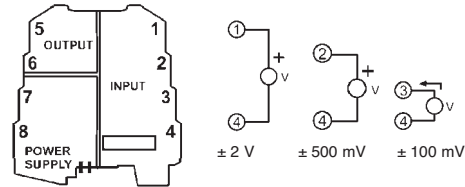

OUTPUT

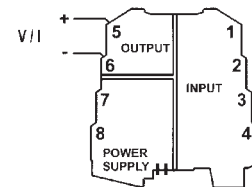

DIMENSIONS

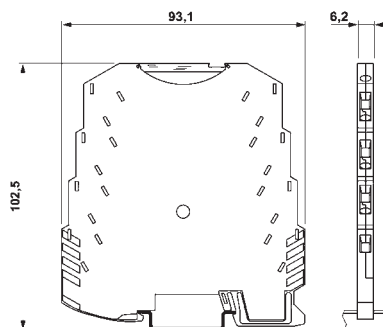

General Description

The K109LV instrument is a three points galvanic insulator, with input on high sensitivity voltage, and active output. The instrument is able to acquire low quantity direct voltage signals, e.g. those coming from a current shunt. It has 15 input scales, which can be selected by a DIP-switch.

Furthermore, it has the following characteristics:

- Detection of shunt release.
- Programmable rejection for 50 Hz or 60 Hz of mains power supply.
- Additional filter to stabilise readings.
- Input capacities can be set as bipolar or monopolar.
- Inverted output scales.
- Input overloading up to ± 50 V.

The module's main features are its compact size (6.2 mm), attachment to a 35 mm DIN rail, bus-conductor power supply option, quick connection by spring terminals and easy configuration in the field by DIP-switch.

Technical Features

Power Supply :	19.2..30 Vdc.
Consumption :	max 22 mA at 24 Vdc (with output at 21 mA and indicator light ON). < 600 mW.
Dissipation :	< 600 mW.
Polarity of Input Capacities :	Can be set as bipolar or monopolar.
Input (Terminals: 3 - 4) :	Capacities: 25 mV, 50 mV, 60 mV, 75 mV, 80 mV, 100 mV. Input Impedance: 50 k Ω .
Input (Terminals: 2 - 4) :	Capacities : 120 mV, 150 mV, 200 mV, 250 mV, 300 mV, 400 mV, 500 mV. Input Impedance: 250 k Ω .
Input (Terminals: 1 - 4) :	Capacities : 1000 mV, 2000 mV. Input Impedance: 1 M Ω .
Max Input :	± 50 V.
CMRR ^(*) :	> 160 dB, referred to the power supply and output side.
DMRR ^(**) :	> 55 dB.
Voltage Output :	0.5 Vdc, 1.5 Vdc, 0..10 Vdc, 2..10 Vdc. Minimum load resistance 2 k Ω .
Current Output :	0..20 mA, 4..20 mA, 20..0 mA, 20..4 mA. Maximum load resistance 500 Ω .
Output in case of over-range/fault:	According to setting (see Output Limits section).
Maximum voltage :	approximately 12.5 V.
Maximum current :	approximately 25 mA.

^(*) The values are valid at the set rejection frequency, with the filter ON.

^(**) For disturbance values whereby the input signal peak does not exceed their acceptability.

Installation rules

This module has been designed for assembly on a DIN 46277 rail. Assembly in vertical position is recommended in order to increase the module's ventilation, and no raceways or other objects that compromise aeration must be positioned in the vicinity.

Do not position the module above equipment that generates heat; we recommend positioning the module in the lower part of the control panel or container compartment. We recommend rail-type assembly using the corresponding bus connector (Code K-BUS) that eliminates the need to connect the power supply to each module.

Inserting the module in the rail

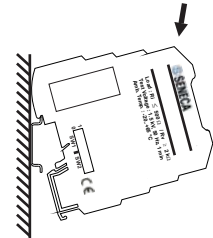

- 1 - Attach the module in the upper part of the rail.
- 2 - Press the module downwards.

Removing the module from the rail

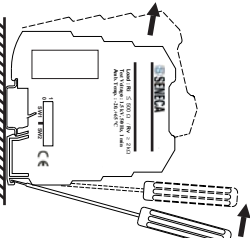

- 1 - Apply leverage using a screwdriver (as shown in the figure).
- 2 - Rotate the module upwards.

Using the K-BUS connector



- 1 - Compose the K-BUS connectors as required in order to obtain the number of positions necessary (each K-BUS permits the insertion of no. 2 modules).
- 2 - Insert the K-BUS connectors in the rail by positioning them on the upper side of the rail and then rotating them downwards.

IMPORTANT! Pay particular attention to the position of the protrudent terminals of the K-BUS. The K-bus must be inserted in the guide with the protrudent terminals on the left (as shown in the figure) otherwise the modules are turned upside down.

- Never connect the power supply directly to the bus connector on the DIN rail.
- Never tap power supply from the bus connector either directly or by using the module's terminals.

SHUNT RELEASE DETECTION

A shunt disconnection detection function can be activated by the DIP-switch settings. It applies to the most sensitive inputs, which lead to terminals M2 and M3. When this function is enabled, shunt release is detected as a positive saturation of the input and is interpreted as a fault.

The event is signalled visually by rapid flashing of the LED (see section: **LED Indications on the frontal panel**) and the output is taken to fault condition (to the value of the set Over-Range - see **Output Limits** section). Use of this function slightly degrades

SETTING OF THE DIP-SWITCHES

Factory setting

All the module DIP switches are at position 0 as default configuration.

This set corresponds to the following configuration :

Input Signal	→ 0.60 mV
Bipolar input	→ No
50/60 Hz mains frequency Rejection	→ 50 Hz
Input Filter	→ Present
Shunt Detection	→ Not Activated
Output Signal	→ 4..20 mA
Over Range	→ YES: a 2.5% over-range value is accepted; a 5% over-range value is considered a malfunction.

It is understood that this configuration is valid only with all the DIP switches at position 0. If also one Dip is moved, it is necessary to set all the other parameters as indicated on the following tables.

Note: for all following tables:

The indication ● indicates that the DIP-switch is set in Position 1 (ON).

No indication is provided when the DIP-switch is set in Position 0 (OFF).

INPUT SIGNAL AND SCALE DETAILS											
SW1			Measure F.S.	Physical F.S.	Terminal +	SW1			Measure F.S.	Physical F.S.	Terminal +
1	2	3	4		Toward M4	1	2	3	4		Toward M4
●	●	●	60 mV	± 100 mV	M3	●	●	●	150 mV	± 250 mV	M2
●	●	●	25 mV	± 50 mV	M3	●	●	●	200 mV	± 250 mV	M2
●	●	●	50 mV	± 50 mV	M3	●	●	●	250 mV	± 250 mV	M2
●	●	●	60 mV	± 100 mV	M3	●	●	●	300 mV	± 500 mV	M2
●	●	●	75 mV	± 100 mV	M3	●	●	●	400 mV	± 500 mV	M2
●	●	●	80 mV	± 100 mV	M3	●	●	●	500 mV	± 500 mV	M2
●	●	●	100 mV	± 100 mV	M3	●	●	●	1000 mV	± 1000 mV	M1
●	●	●	120 mV	± 250 mV	M2	●	●	●	2000 mV	± 2000 mV	M1

The physical Full Scale is shown in order to evaluate the error and the transmission resolution, in addition to the acceptability of the input and, therefore, the useful margin before a fault is signalled.

MONOPOLAR OR BIPOLAR INPUT

SW1 5	● Bipolar
	● Monopolar

50/60 Hz Mains Frequency Rejection		INPUT FILTER ^(*)	
SW1 6	● 60 Hz	SW1 7	● Present
	● 50 Hz		● Absent

^(*) The filter increases rejection at mains frequency disturbance, and stabilises reading, reducing measurement noise. It is preferable to always keep the filter ON, except in cases where maximum response speed is required.

SHUNT DETECTION ^(**)	
SW1 8	● YES
	● No

^(**) It entails an injection of current of less than 3 μ A, which can degrade the instruments precision, and applies to the inputs leading to terminals M2 and M3.

OUTPUT SIGNAL	
SW2 1 2 3	0..20 mA
●	4..20 mA
●	20..0 mA ^(*)
●	20..4 mA ^(*)
●	0..10 Vdc
●	0..5 Vdc
●	1..5 Vdc
●	2..10 Vdc

^(*) They are inverted output scales, for which the fault is represented by the lower extreme.

OVER-RANGE ^(*)	
SW2 4	● YES: a 2.5% over-range value is acceptable; a 5% over-range value is considered a malfunction.
	● NO: the malfunction alone causes a 2.5% over-range value.

^(*) See the table below for the corresponding values.

Output Limits

The following are the off-scale programmable limits which are applied to the output signal:

Nominal Value	Over-Range $\pm 2.5\%$	Over-Range $\pm 5\%$
20 mA	20.5 mA	21 mA
4 mA	3.5 mA	3 mA
0 mA	0 mA	0 mA
10 Vdc	10.25 Vdc	10.5 Vdc
5 Vdc	5.125 Vdc	5.25 Vdc
1 Vdc	0.875 Vdc	0.75 Vdc
2 Vdc	1.75 Vdc	1.5 Vdc
0 Vdc	0 Vdc	0 Vdc

Electrical Connections

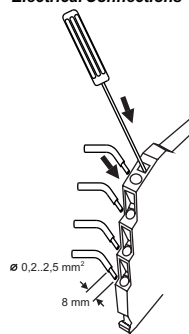

The module has been designed for spring-type terminal electrical connections.

Proceed as follows to make the connections:

- 1 - Strip the cables by 0.8 mm
- 2 - Insert a screwdriver in the square hole and press it until the cable lock spring opens.
- 3 - Insert the cable in the round hole.
- 4 - Remove the screwdriver and make sure that the cable is tightly fastened in the terminal.

Power supply

There are various ways to provide the K Series modules with power.

- 1 - Direct power supply to the modules by connecting 24 Vdc power supply directly to Terminals 7 (+) and 8 (-) of each module.

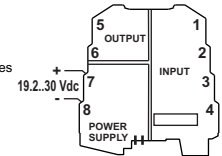

- 2 - Using the K-BUS connector accessory for the distribution of the power supply to the modules via bus connector, in this way eliminating the need to connect the power supply to each module.

The bus can be supplied from any of the modules; the total absorption of the bus must be less than 400 mA. Higher absorption values can damage the module. An appropriately sized fuse must be connected in series to the power supply.

- 3 - Using the K-BUS connector accessory for the distribution of the power supply to the modules via bus connector and the K-SUPPLY accessory for the connection of the power supply.

The K-SUPPLY accessory is a 6.2 mm wide module that contains a set of protections designed to protect the modules connected via bus against over-voltage loads.

The bus connector can be provided with power using the K-SUPPLY module if the total absorption of the bus is less than 1.5 A. Higher absorption values can damage both the module and the bus. An appropriately sized fuse must be connected in series to the power supply.

Input

For the electrical connections, we recommend using a screened cable.

Details of terminals

- Terminal 1: Input powered up to 2 Vdc (Physical full scale: 2 V and 1 V).
- Terminal 2: Input powered up to 500 mV (Physical full scale: 500 mV and 250 mV).
- Terminal 3: Input powered up to 100 mV (Physical full scale: 100 mV and 50 mV).
- Terminal 4: Return (GND).

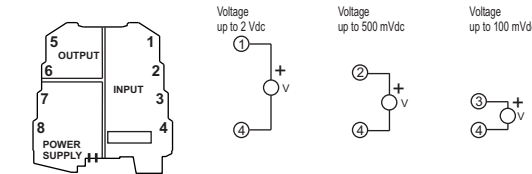

Output

Voltage connection - Current connection (applied current).

The use of shield cables is recommended for the electronic connections.

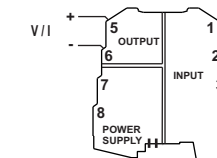

Note: in order to reduce the instrument's dissipation, we recommend to guarantee a load > 250 Ω to the current output.

LED indications on the frontal panel

Red LED	Meaning
Rapid flashing	Internal fault: power supply, offset or reference off limit, input acceptability exceeded. Internal error. Input overloaded. Release of shunt (if enabled.)
Slow flashing	Function for detecting the disconnection of the shunt required for an input capacity, for which it is not available (M1).
Steady ON	Output limiting in progress (overcoming of the set over-range).

Behaviour due to fault or defect

Any defect causing the LED to flash rapidly, takes the output into fault condition, i.e. to the Over-Range value (2.5% or 5% according to the setting of the DIP-switches). For direct scales, the output takes on the Over-Range value corresponding to the maximum value, whereas, for the inverse scales (20..0 mA / 20..4 mA) it takes on the value corresponding to minimum value. If slow flashing occurs, the output remains on zero. The acceptability of the input is obviously determined by the physical full scale for the selected scale.

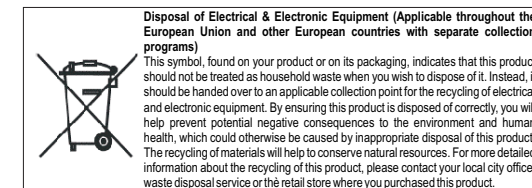

This document is property of SENECA s.r.l. Duplication and reproduction are forbidden, if not authorized. Contents of the present documentation refers to products and technologies described in it. All technical data contained in the document may be modified without prior notice Content of this documentation is subject to periodical revision.